

We recommend you hire an experienced finish carpenter or floor installer to achieve quality results with all Duchateau® Wall Coverings. The right tools are key for a successful installation.

RECOMMENDED TOOLS:

- 23 Gauge Nail Gun
- 18 Gauge Nail Gun
- Glue Applicator and Titebond II Glue or similar (for edges)
- Construction Glue (Liquid Nails or similar)—use between the back panel and the drywall or OSB and for hardboard area
- Jigsaw* to open outlet spaces
- Laser
- Chalk Line
- Countersink Bit (if you use flathead screws on the back panel)
- Finish Miter Saw*—we recommend a Dewalt that has a horizontal capacity of 16”
- Finish Table Saw*
- Air Compressor
- Step Ladder or Scaffold, if necessary
- Rubber Mallet
- Drill
- Measuring Tape
- Ruler and Scoring Knife
- Black Paint, Tray and Roller
- Black Tape (for edges and joints in lieu of paint)

*Make sure your knives are in prime condition to work with pre-finished lumber and wood veneers.

RECOMMENDATIONS TO BEGIN:

- We recommend you paint the walls where you will apply the products with Matte Black Paint to make any gaps less noticeable.
- Arrange 1 to 2 rows of the Duchateau wall covering tiles on the floor. This will allow you to see your pattern and define your cuts. Mark your floor outlets.
- Duchateau wall covering tile walls can be installed in a Vertical or Horizontal direction. Installation at any other angle is also acceptable although more waste is created.
- Make sure you check if your walls are aligned from floor to ceiling. Once this is checked, we recommend you draw a straight line that you will follow as a guide. Draw the lines vertically and horizontally to determine a starting point and create your guidelines. We recommend the use of a Laser and Chalk line to draw your starting lines.
- Allow ¼” gap all around your installation area. This is between Duchateau wall covering tiles and ceiling or crown, between tiles and floor or baseboard and on the edges next to a wall or on a corner. Use shims if necessary. This will allow for product expansion and contraction.
- Any wood trim used with the Duchateau wall covering tiles should become part of the panels and the ¼” gap should be left after the trim.

INSTALLATION INSTRUCTIONS A (CURVA, KRESCENT, KUADRA, PARALLELS, VERTEX STYLES):

1. Always start from the bottom. If starting from Left to Right, place the viewable hardboard back panel to the right (If you start from Right to Left, the hardboard back panel should be on the Left).
2. The back panel area can have as many nails as needed (at least 4 on each hardboard area).
3. The use of flathead screws are also an option as long as you use a Counter Sink bit first and then drill in the flat head screws. If you start from Right to Left, place the back panel to the Left. If possible, make sure nails or screws in the back panel go lower than the back panel to avoid having those elements throw the interlocking wall covering tiles out of line.
4. Duchateau wall covering tiles can also be centered with the wall; in that case you can place the back panel in either direction and make the adjustments at the ends. Make sure you keep the pieces you cut off as these pieces can be used on the other side if needed.
5. The panels must be glued and nailed for the warranty to apply; the combination of both elements will be helpful during installation and will also prevent the panels from warping in the future. Use a good amount of construction adhesive on the back panel.
6. We also recommend the use of a small amount of Adhesive on the areas where the back panel is visible and the pieces will interlock on top. Use a very small amount, and not very close to the edges, to avoid glue spreading over the Duchateau wall covering tiles.
7. Use #18 Gauge Nails for more strength on the edge of the panels and on the hardboard.
8. Use #23 Gauge Nails on the center areas of your tile—the finished viewable areas.
9. As you assemble the tiles, make sure they are assembled tight. Use a rubber mallet and a scrap piece of wood to assist.
10. Apply the nails on the corners where parts of the tile itself intersect and in an upward angle on the lower part of the wall. At eye level areas, be very careful how you use the #23 Gauge Nails and make sure they go through exactly on intercepting corners to avoid visible nails on the Duchateau wall covering tiles and on the upper areas of the wall. Nail through the top corners. You can also nail on the face at intersecting corners, but use a downward angle. Make sure the nails go through the wood. Use adequate pressure on the Nail Gun.

INSTALLATION INSTRUCTIONS B (EDGE, INFUSE, KUBIK STYLES):

1. Make sure you use a Scoring Knife for every cut over veneers. Use finish veneer blades in good condition for all cuts.
2. You can start from the top or the bottom. Make sure you analyze how many Duchateau wall covering tiles you will need and try to avoid cutting the solid, 3-D elements of the Duchateau wall covering tile on the top or the bottom. We recommend you lay out the wall covering tiles on the floor first.
3. The panels must be glued and nailed for the warranty to apply; the combination of both elements will be helpful during installation and will also prevent panels from warping in the future. You can use #18 Gauge Nails on the edge of the panels. On the lower parts of your wall, you can use #23 Gauge Nails on the intersections between the veneer area and solid elements. Make sure you nail in an upward angle. At eye level areas, use only #18 Nails on the edges of the panel all around. On the upper areas of the wall, you can also nail through corners, but use a downward angle on the top areas that will not be visible. Make sure the nails go through the wood to avoid interlocking problems. Use adequate pressure on your nail guns.

IMPORTANT: Do not nail through the veneer of the Duchateau wall covering tiles. The nails will be very visible and difficult to touch up.

We also recommend the use of a very small amount of Construction Adhesive on the edges where the wall covering tiles will intercept. Make sure you apply this on the lower part of the edge to avoid the glue to spread over the finished veneer.

SPECIAL APPLICATIONS:

OUTLET CUTOFF:

- Mark your outlet distance and elevation on your test pattern and on the wall.
- Mark your tile and drill 4 holes for each corner of the outlet.
- Using a Jigsaw to cut a line from corner to corner.
- Turn the piece around, trim and detail.
- Test on wall before applying glue.

FIREPLACES & HEATERS:

We do NOT recommend the use of Duchateau wall covering tiles around a Fireplace or a Heater. The Duchateau tiles are made with flammable materials. Check your local codes. In most areas, this is prohibited by code "A". Optional A Rating fire retardant is available for an additional fee.

BATHROOMS:

Duchateau wall covering tiles may be used in bathrooms as long as they are NOT installed near or at splash areas.

CEILING APPLICATIONS:

In general we **do not** recommend using these products for ceiling applications. Ceiling applications are not approved nor recommended with Curva, Krescent, Kuadra, Parallels, Wave, Arc Chevron, Curva Chevron, Scale or Vertex styles. If the Edge, Infuse or Kubik styles are used on a ceiling application, three #18 Gauge Nails (at least 1-1/4" long) should be used over each solid part of the tile as an extra precaution and must be installed by a Licensed Flooring Contractor or Licensed Finish Carpenter with ceiling installation experience. Special glues should be used and must be specified by the Project Engineer and/or signing Architect for the project and also combined with the use of #18 Gauge Nails along the edges of each tile.

CONCRETE WALLS:

For installation over concrete walls, wood separators and OSB boards are recommended. Direct installation over concrete is not covered by the warranty.

CUSTOM TRIMS:

- Duchateau can manufacture any custom trim you may need with the same wood species and finishes of Duchateau wall covering tiles (outlet trim, window trim, casing, baseboard, crown, etc.). Please contact us for a quote.
- We recommend trim products for the edges of our products. A rectangular 3/4" x 1" trim is available in 72" length.
- Duchateau wall covering tiles can be mitered on corners. Make sure you cut the parts at the same length on each side to ensure the 3-D heights match.
- As a secondary option for corners, we also offer a square 3/4" x 1" trim available in 72" length.

KUADRA

INSTALLATION GUIDE



DuCHÂTEAU

THANK YOU FOR YOUR PURCHASE OF DUCHÂTEAU WALL COVERINGS.

We recommend you hire an experienced finish carpenter or wood flooring installer to achieve quality results with all DuChâteau Wall Coverings. The right tools are key for a successful installation.

IMPORTANT:

BE SURE TO FULLY INSPECT SHIPMENT FOR ANY DAMAGE IMMEDIATELY UPON ARRIVAL PRIOR TO INSTALLATION. ANY DAMAGE MUST BE REPORTED IMMEDIATELY TO CUSTOMERSERVICE@DUCHATEAU.COM.

WARNING:

IMPROPERLY INSTALLING DUCHÂTEAU WALL COVERINGS MAY RESULT IN VOIDING YOUR WARRANTY. PROTECT YOUR WARRANTY AND YOUR INVESTMENT, ALWAYS FASTEN AND GLUE DUCHÂTEAU WALL COVERINGS.

CONTENTS

RECOMMENDED TOOLS	4
HORIZONTAL INSTALLATION	5
VERTICAL INSTALLATION	21

RECOMMENDED TOOLS

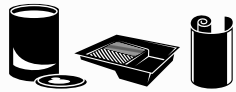

FLAT BLACK PAINT, TRAY AND PROTECTIVE FLOOR COVER



BRUSH AND ROLLER



BLACK TAPE



LASER LEVEL OR LEVEL



CHALK LINE



CONSTRUCTION ADHESIVE AND APPLICATOR



FINISH MITER SAW* WITH A HORIZONTAL CAPACITY OF 16"



FINISH TABLE SAW*



JIGSAW



23 GAUGE NAIL GUN WITH NAILS



18 GAUGE NAIL GUN WITH NAILS



FLATHEAD SCREWS - OPTIONAL



DRILL



AIR COMPRESSOR



COUNTERSINK BIT
- IF USING FLATHEAD SCREWS



STEP LADDER OR SCAFFOLD
- IF NECESSARY



RUBBER MALLET



MEASURING TAPE, RULER AND SCORING KNIFE

*NOTE: MAKE SURE YOUR BLADES ARE IN PRIME CONDITION TO WORK WITH PRE-FINISHED LUMBER.

HORIZONTAL

PREPARATION

STEP 1

First, check the wall(s) is level from floor to ceiling and edge-to-edge.

If not, be sure to note the differences in height and/or width, and adjust layout accordingly.

Fix any irregularities on the surface of your installation area that would affect how the tiles lay.

TOOLS: LASER LEVEL OR LEVEL

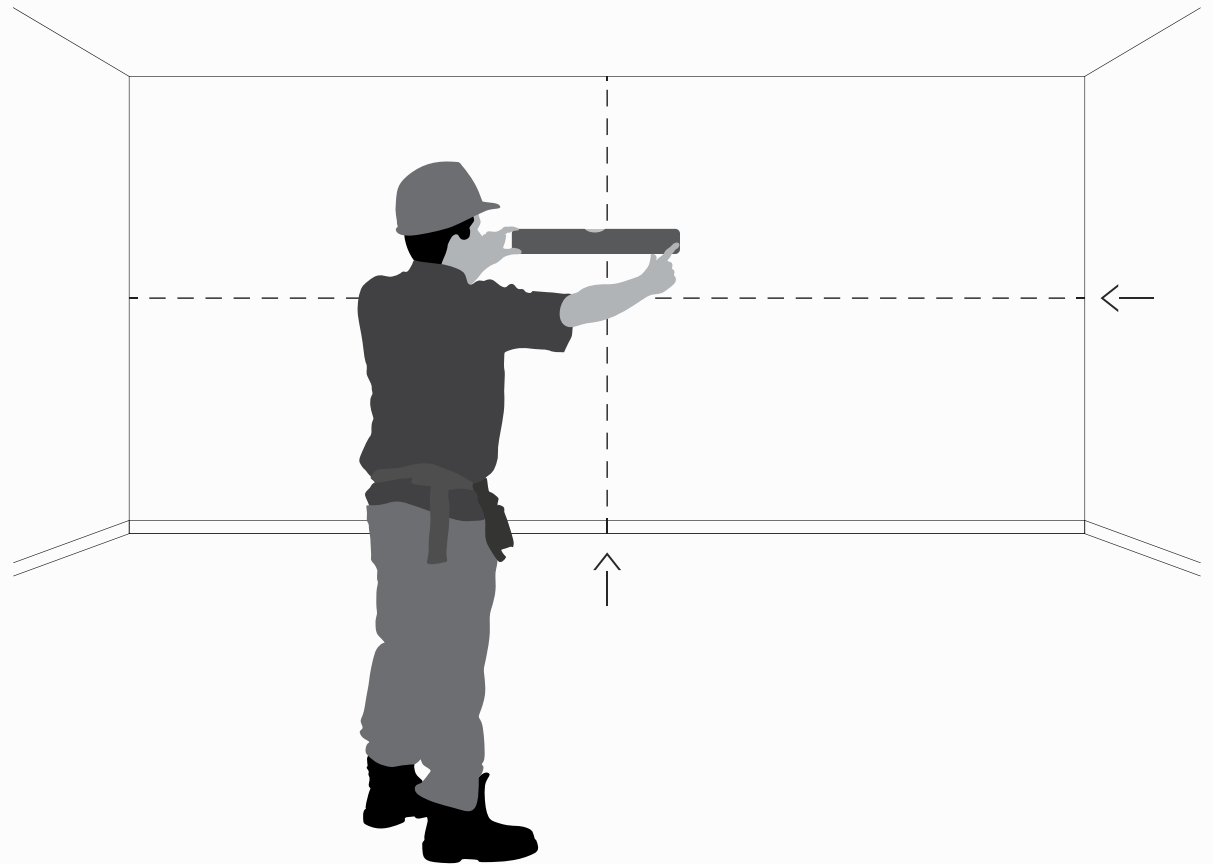

PREPARATION

STEP 2

Paint the desired installation area matte black to hide any potential gaps between or within tiles due to expansion and contraction of wood over time; 1/16" gap is normal between tiles.

For edges, use black tape to further conceal paint imperfection, if needed.

FLAT BLACK PAINT
PAINT TRAY
TOOLS: PROTECTIVE FLOOR COVER
PAINT BRUSH AND ROLLER
BLACK TAPE



PREPARATION

STEP 3

Leave a 1/4" gap around the perimeter of your installation area, including trim, to allow for product expansion and contraction.

Use shims for an even separation, if necessary.

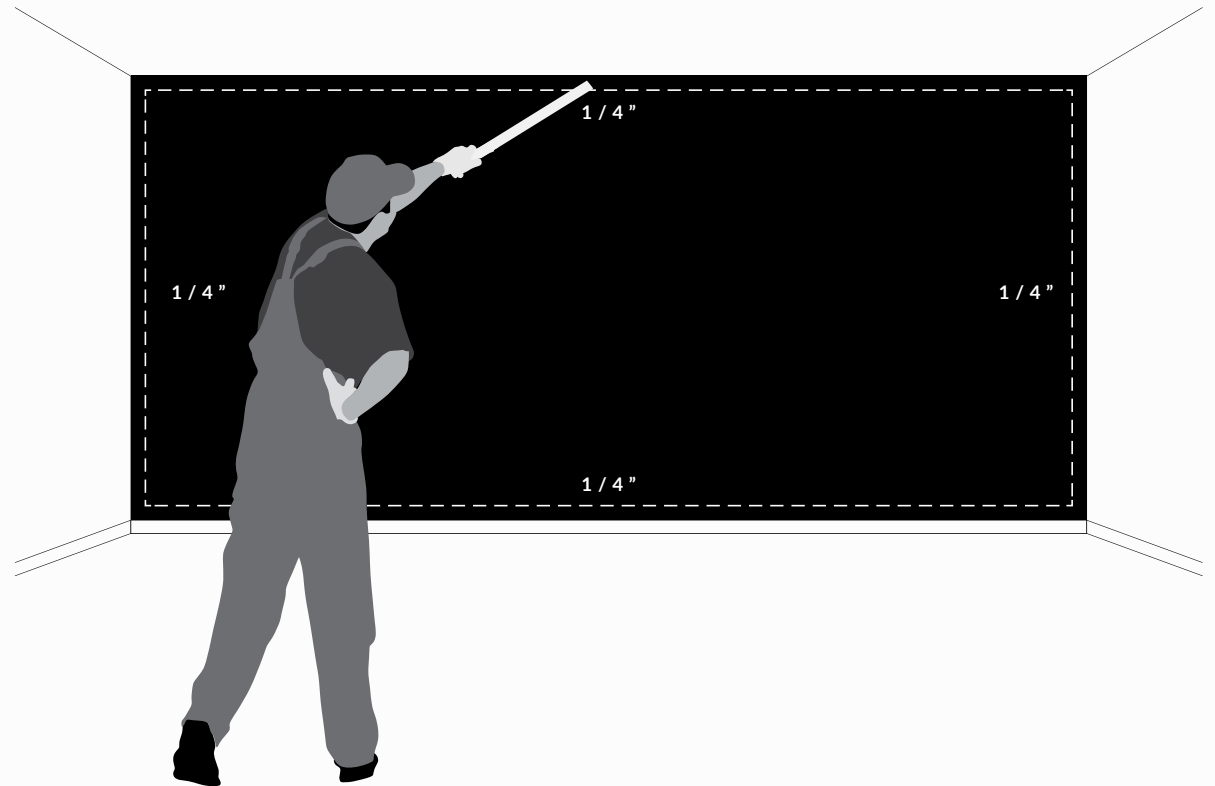

TOOLS: MEASURING TAPE
RULER

PREPARATION

STEP 4

Assess the direction of the tiles you wish to have them installed – horizontal, vertical, and/or even diagonal at any angle.

FIG A. Lay two rows on the floor before installing to plan your wall. Define and mark initial cuts.

FIG B. IMPORTANT: If centered install is desired, mark center piece and measure out ends of wall to ensure both ends of wall coverings are equal before cutting excess.

FIG. A

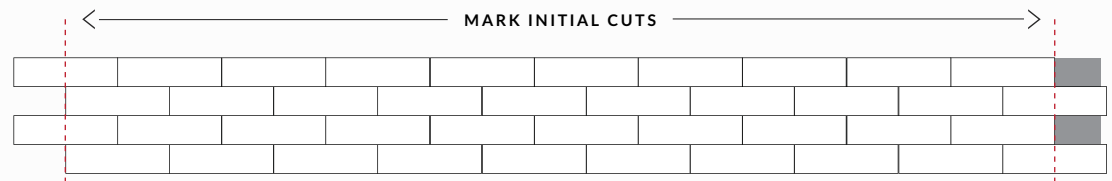
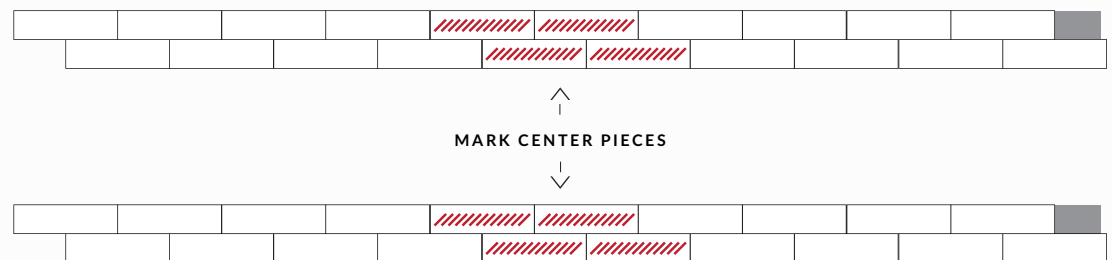

FIG. B (CENTERED INSTALL)



PREPARATION

STEP 5

Measure and mark your horizontal and vertical guidelines using a laser level and chalk line in accordance with the tile dimensions.

TOOLS: LASER LEVEL
CHALK LINE

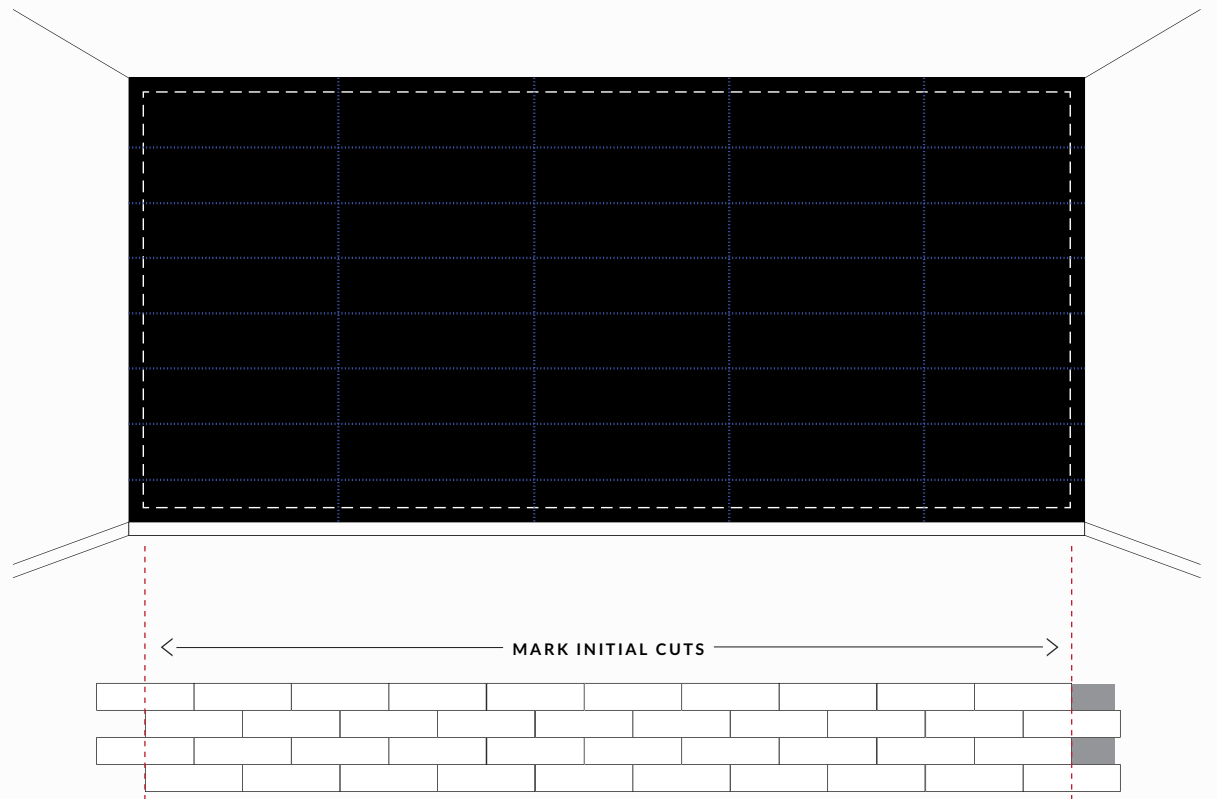

PREPARATION

STEP 6

In prep for outlets, light switches, etc., arrange any other rows of tiles on the floor that will require additional cuts, taking care to mark any outlets and define initial cuts once level; please see special instructions for installing mouldings.

Anticipate final row might need to be trimmed to fit as well.

RULER
TOOLS: JIGSAW AND DRILL
MITER SAW OR TABLE SAW

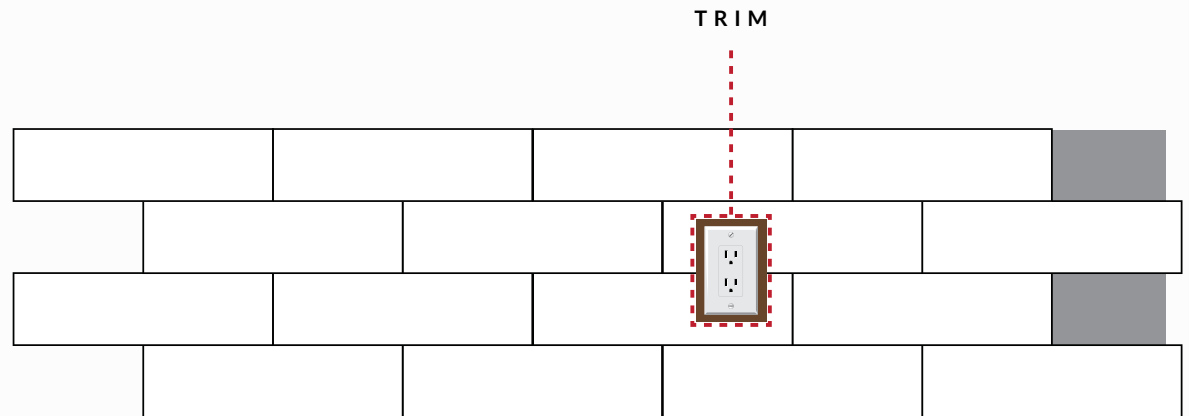

FASTENING

STEP 7

To install HORIZONTALLY, begin in any corner as long as the hardboard back panel is facing the direction of the install. Define and mark initial cuts.

FIG A. Starting from the Left, place the visible hardboard back panel to the Right.

FIG B. Starting from the Right, the visible hardboard back panel should be on the Left.

(NOTE: Initial cuts will vary depending on your desired installation area.)

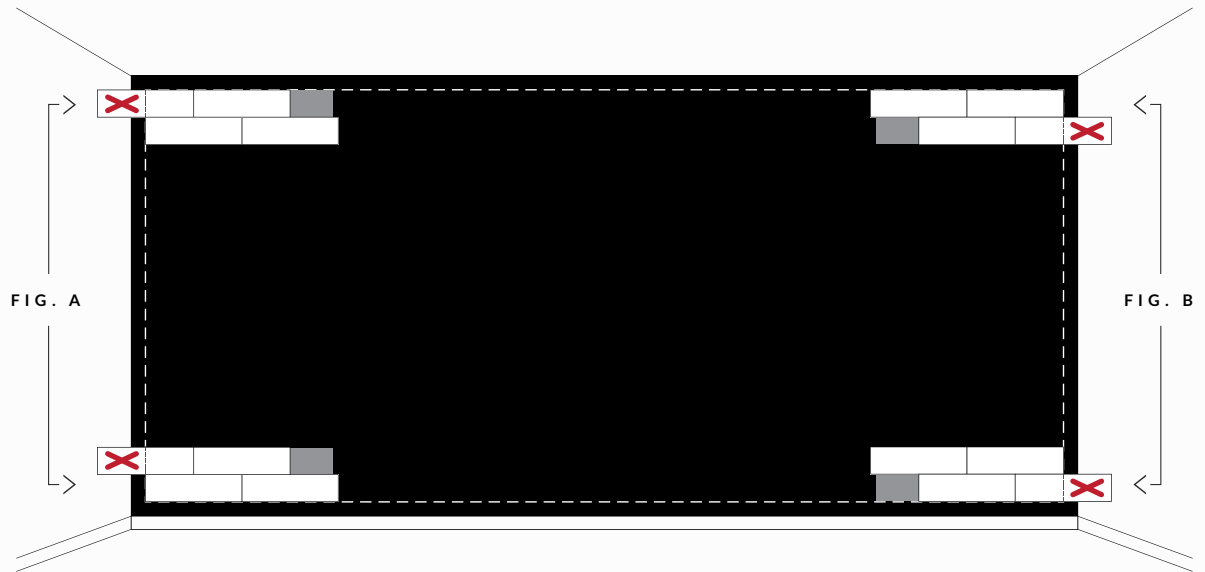

FIG. A

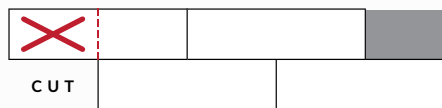
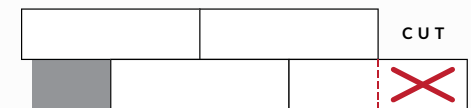

FIG. B



FASTENING

STEP 8

Cut any excess tab off the wall tile in order to be flush with the edge of the wall and ensure proper coverage.

Please note that when cutting any pattern, pieces may fall off due to the vibration of the saw. Simply, glue back on and nail from back to secure it firmly.

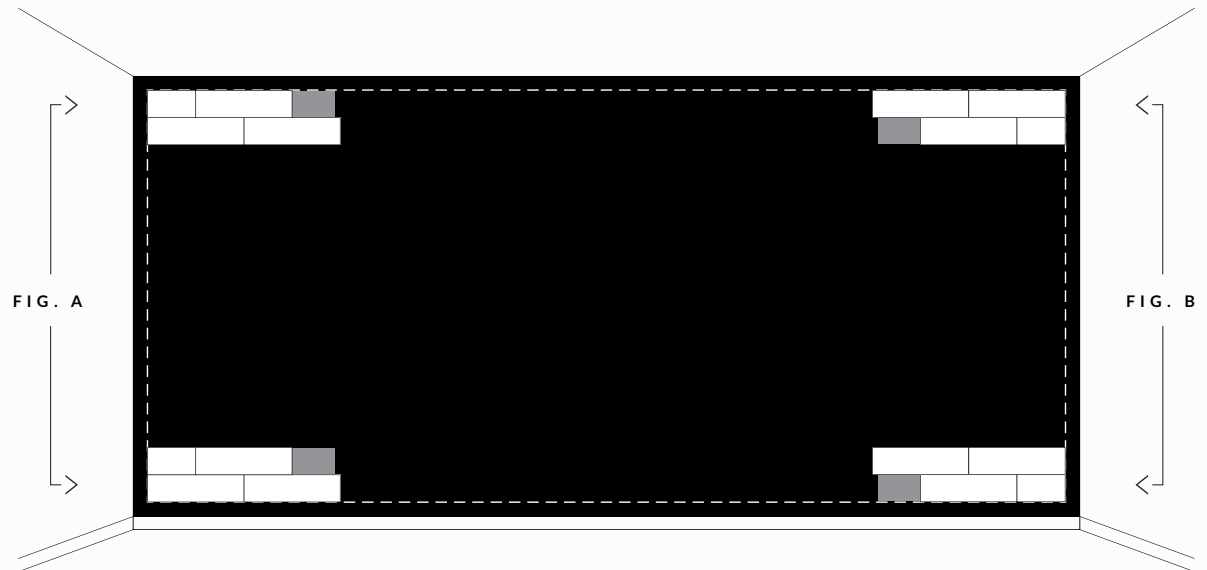

FASTENING

STEP 9

Add adhesive on the back panel, and place the initial tile at the starting point of the installation.

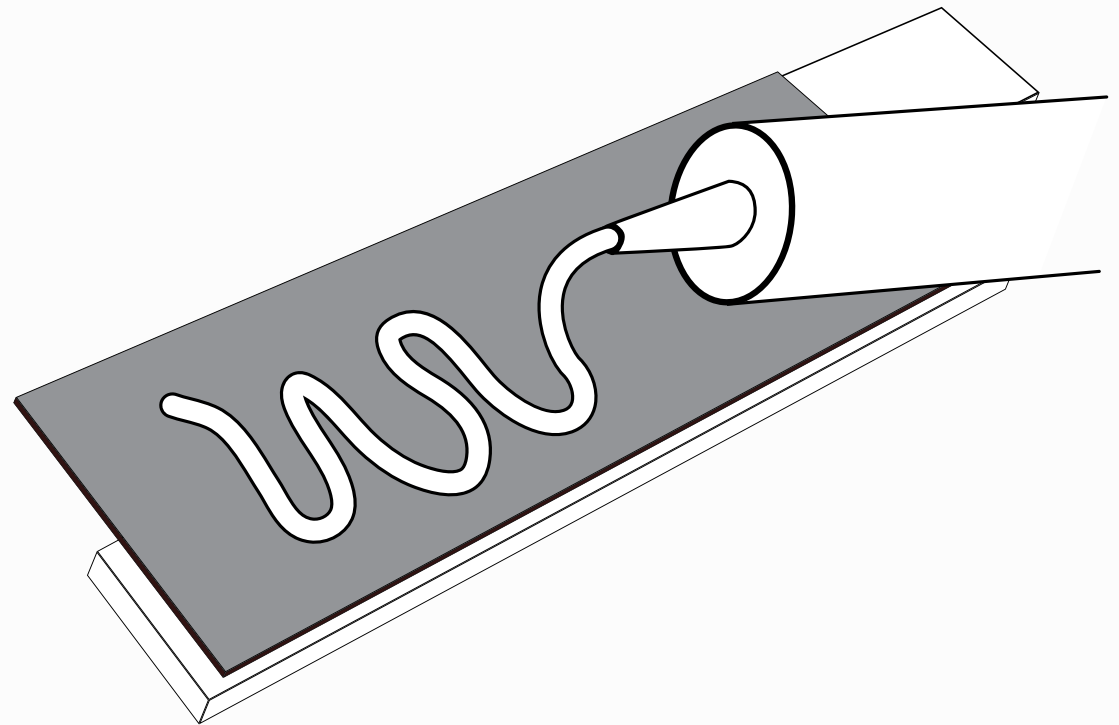

TOOLS: CONSTRUCTION ADHESIVE
APPLICATOR

FASTENING

STEP 10

Once level and aligned, fasten the exposed back panel with at least 4 #18 Gauge Nails.

(OPTIONAL: If using flathead screws, be sure to use a Counter Sink bit first to drill screws below the surface.)

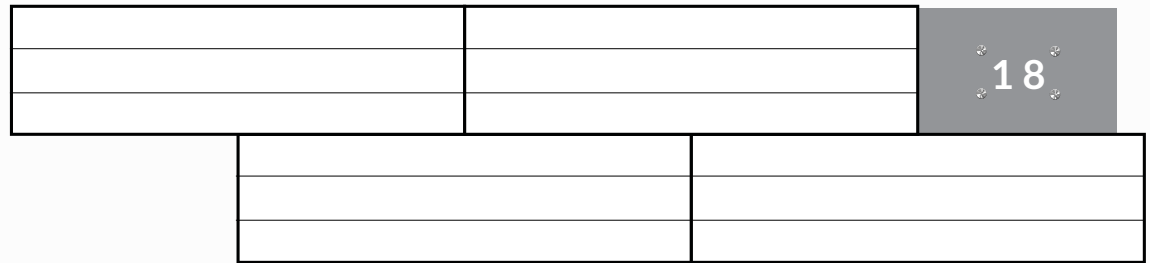

TOOLS: 18 GAUGE NAIL GUN WITH NAILS

FASTENING

STEP 11

Apply pressure on the individual piece when nailing.

Using #23 Gauge Nails, nail in between individual wood pieces, taking care to hide the nails within the 3D volume of each design.

When possible, do not nail on the face of each insert to maintain the finished aesthetic of the wall covering.

TOOLS: 23 GAUGE NAIL GUN WITH NAILS

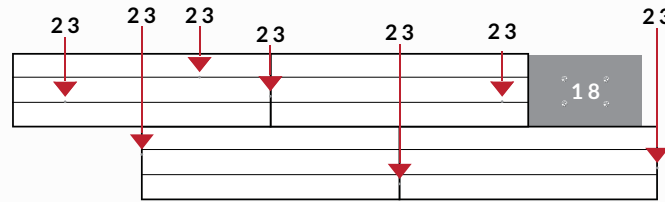

FIG. A: ABOVE EYE LEVEL, USE #23 GAUGE NAILS AT A DOWNWARD ANGLE.

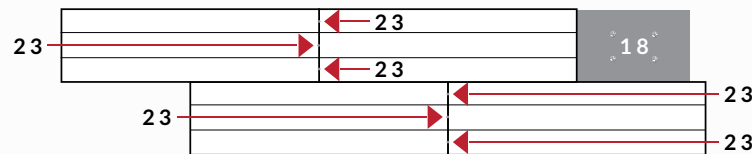

FIG. B: AT EYE LEVEL, USE #23 GAUGE NAILS, NAILING INTO THE EDGES OF EACH PANEL.

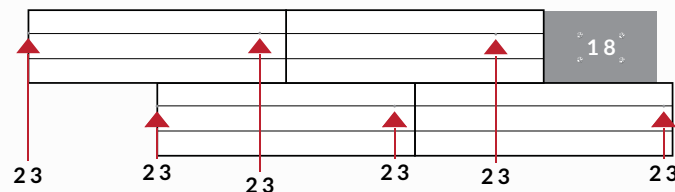
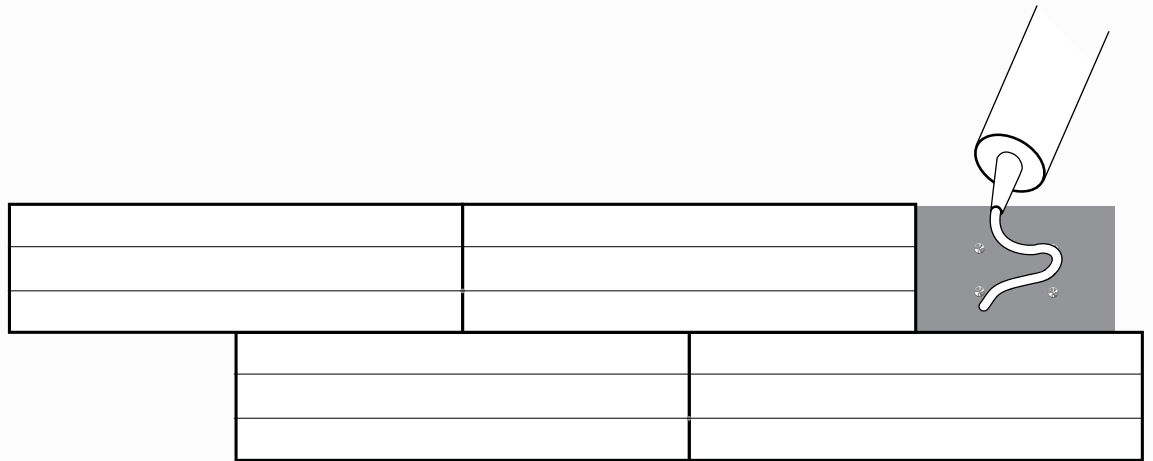

FIG. C: BELOW EYE LEVEL, USE #23 GAUGE NAILS, NAILING AT AN UPWARD ANGLE TO AVOID VISIBLE NAILS.

FASTENING

STEP 12

Now, apply a very small amount of adhesive on the exposed hardwood panel in preparation for the next tile.



TOOLS: CONSTRUCTION ADHESIVE
APPLICATOR

FASTENING

STEP 13

Tightly fit the next adjacent tile; if necessary, use a rubber mallet and a scrap piece of wood to assist.

Remember, a 1/16" separation is normal, as each handmade piece must be allowed to expand and contract.

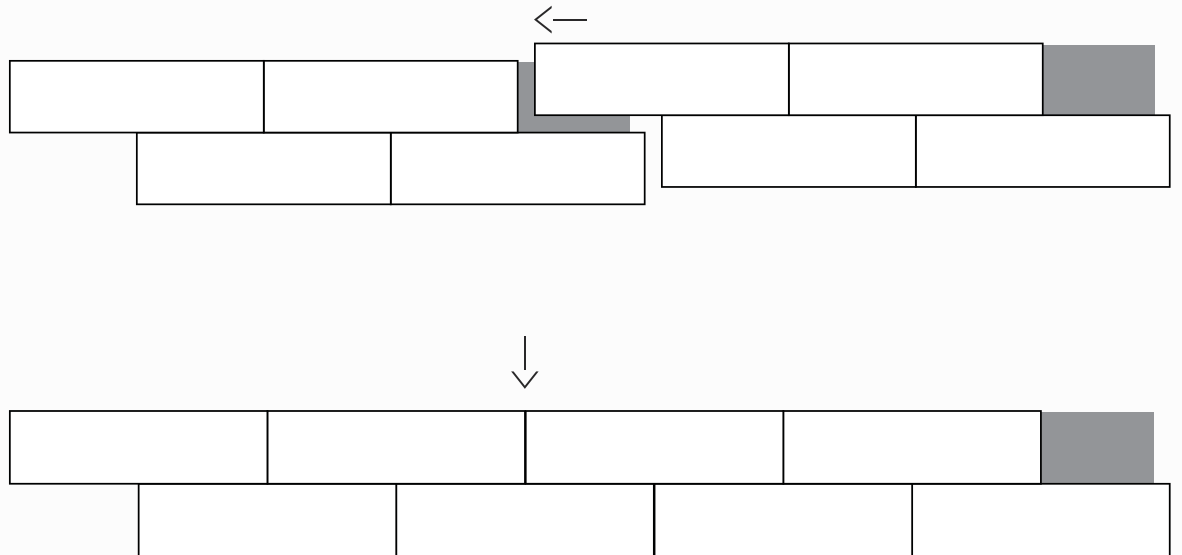

TOOLS: RUBBER MALLET

FASTENING

STEP 14

Make sure each tile and row is level.

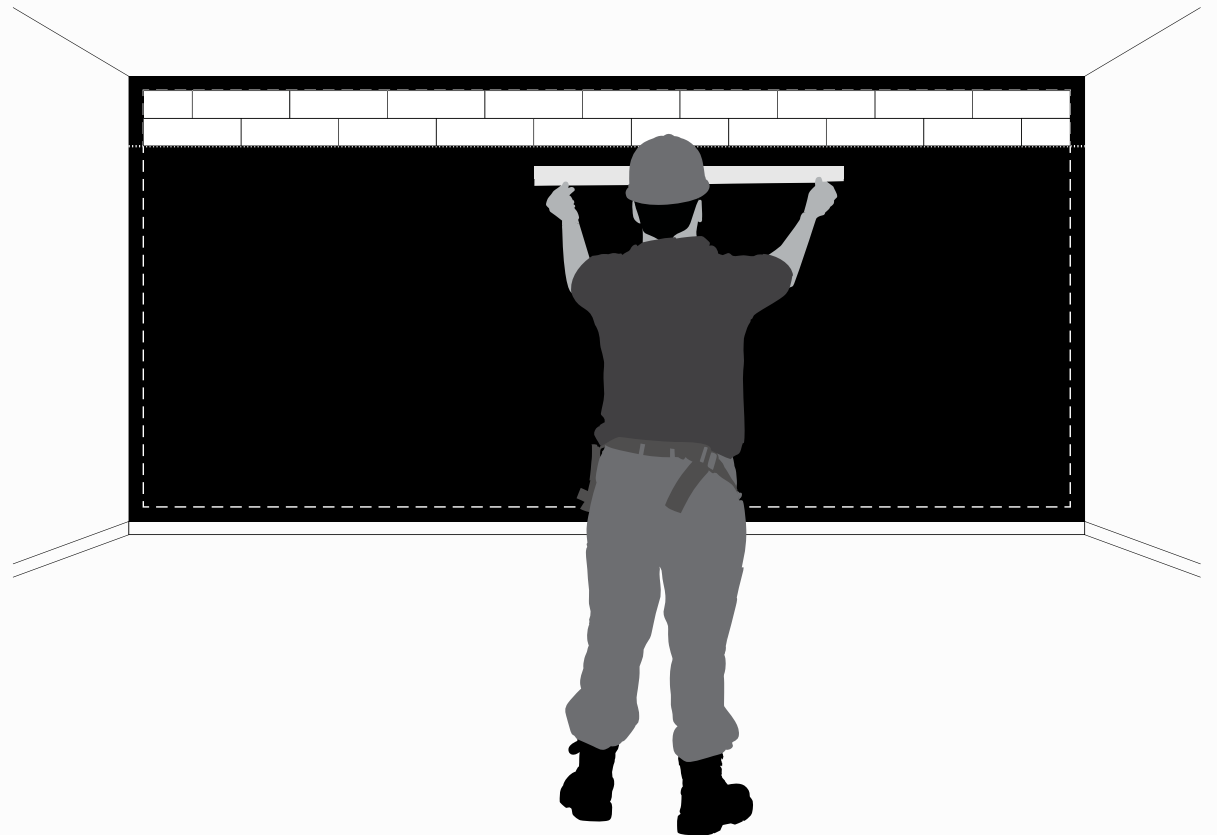

TOOLS: LASER LEVEL OR LEVEL

FASTENING

STEP 15

Repeat this fastening process across the wall, making sure to cut any tiles to fit as you approach the end of the wall.

REMEMBER: THE PANELS MUST BE GLUED AND NAILED FOR THE WARRANTY TO APPLY;
THIS METHOD WILL ALSO PREVENT THE PANELS FROM WARPING IN THE FUTURE.

VERTICAL

PREPARATION

STEP 1

First, check the wall(s) is level from floor to ceiling and edge-to-edge.

If not, be sure to note the differences in height and/or width, and adjust layout accordingly.

Fix any irregularities on the surface of your installation area that would affect how the tiles lay.

TOOLS: LASER LEVEL OR LEVEL

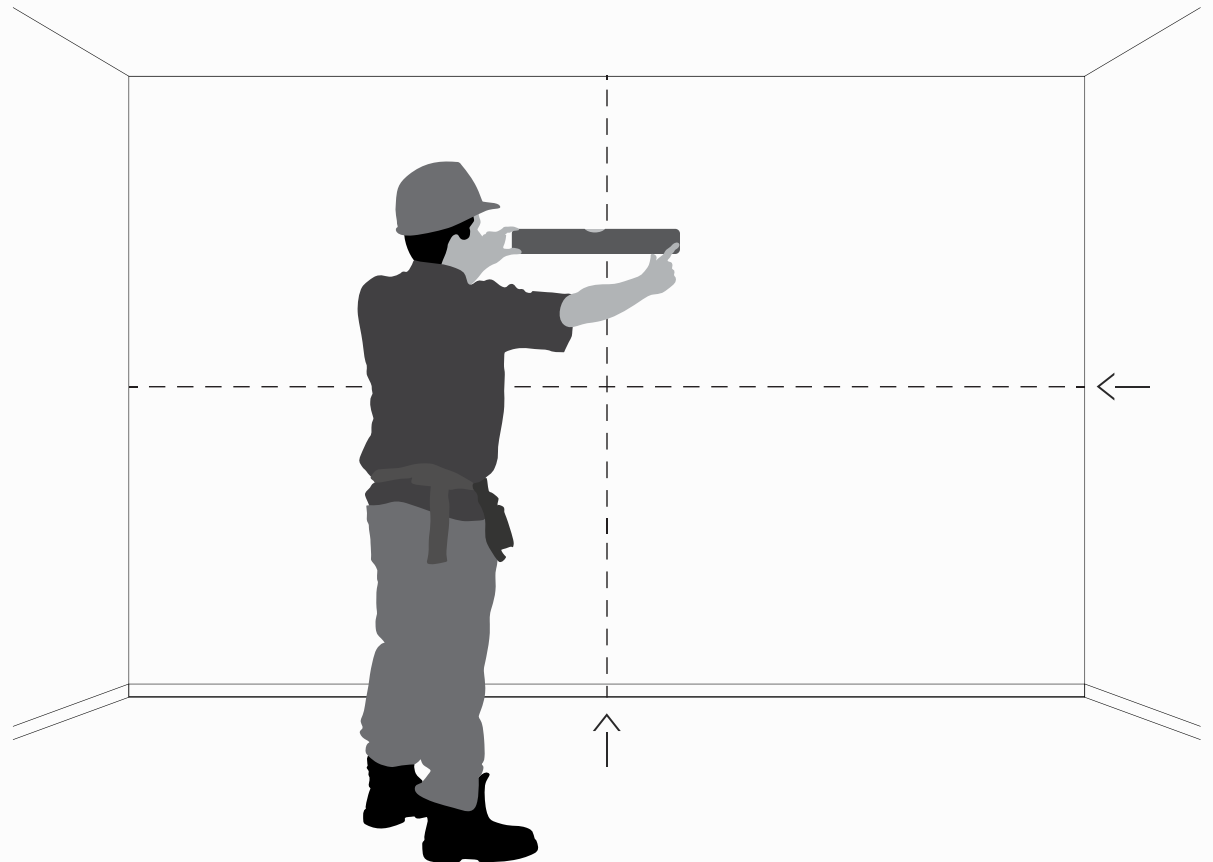

PREPARATION

STEP 2

Paint the desired installation area matte black to hide any potential gaps between or within tiles due to expansion and contraction of wood over time; 1/16" gap is normal between tiles.

For edges, use black tape to further conceal paint imperfection, if needed.

FLAT BLACK PAINT
PAINT TRAY
TOOLS: PROTECTIVE FLOOR COVER
PAINT BRUSH AND ROLLER
BLACK TAPE



PREPARATION

STEP 3

Leave a 1/4" gap around the perimeter of your installation area, including trim, to allow for product expansion and contraction.

Use shims for an even separation, if necessary.

TOOLS: MEASURING TAPE
RULER

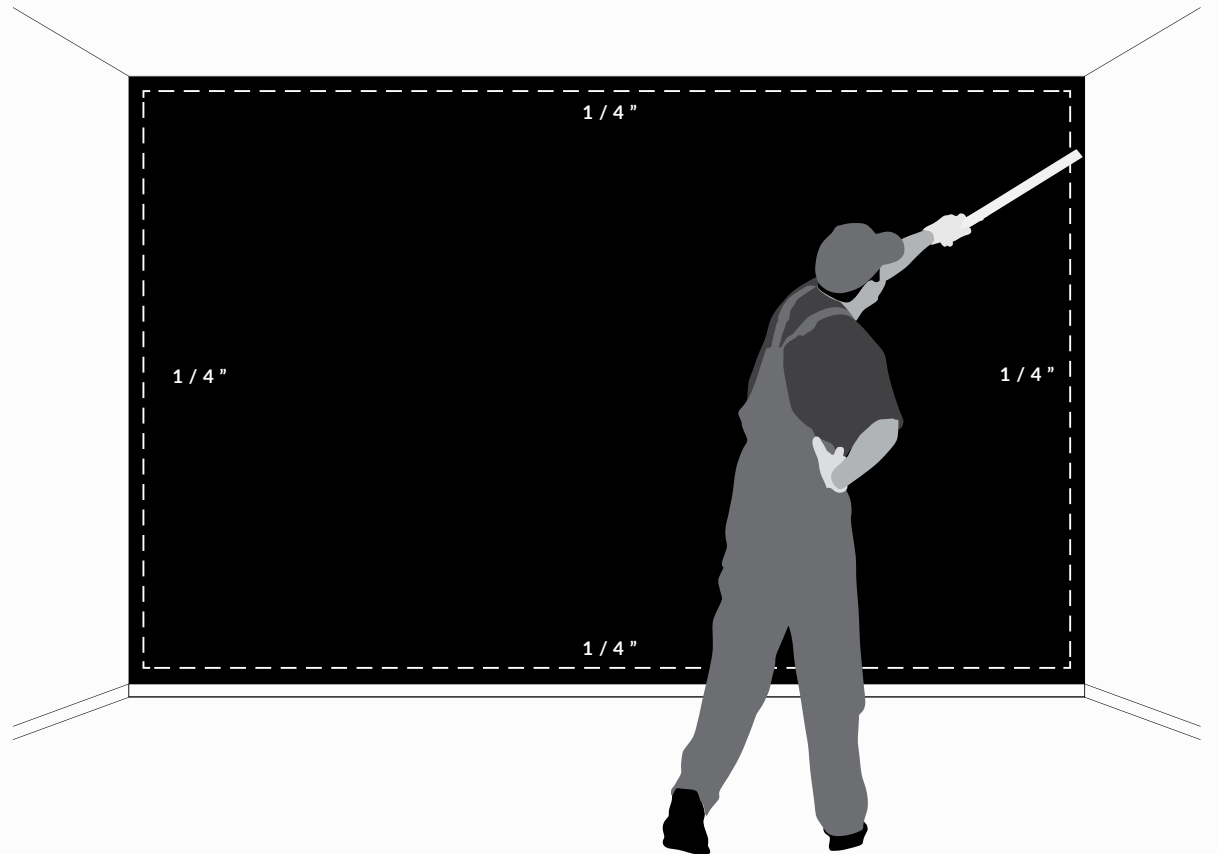

PREPARATION

STEP 4

Assess the direction of the tiles you wish to have them installed – horizontal, vertical, and/or even diagonal at any angle.

FIG A. Lay two rows on the floor before installing to plan your wall. Define and mark initial cuts.

FIG B. IMPORTANT: If centered install is desired, mark center piece and measure out ends of wall to ensure both ends of wall coverings are equal before cutting excess.

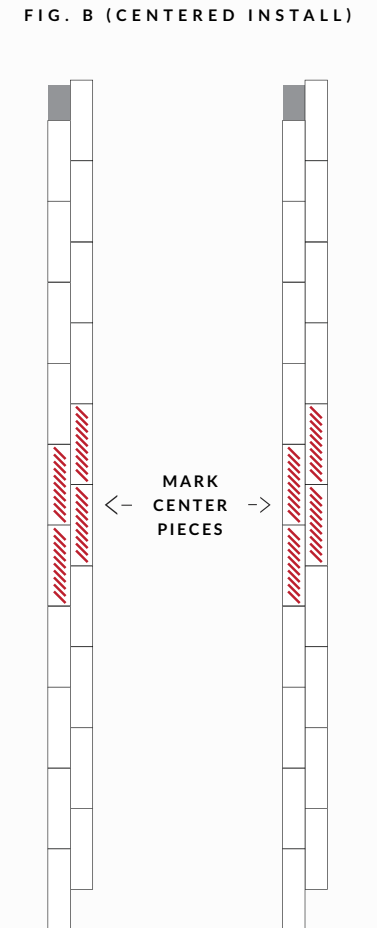
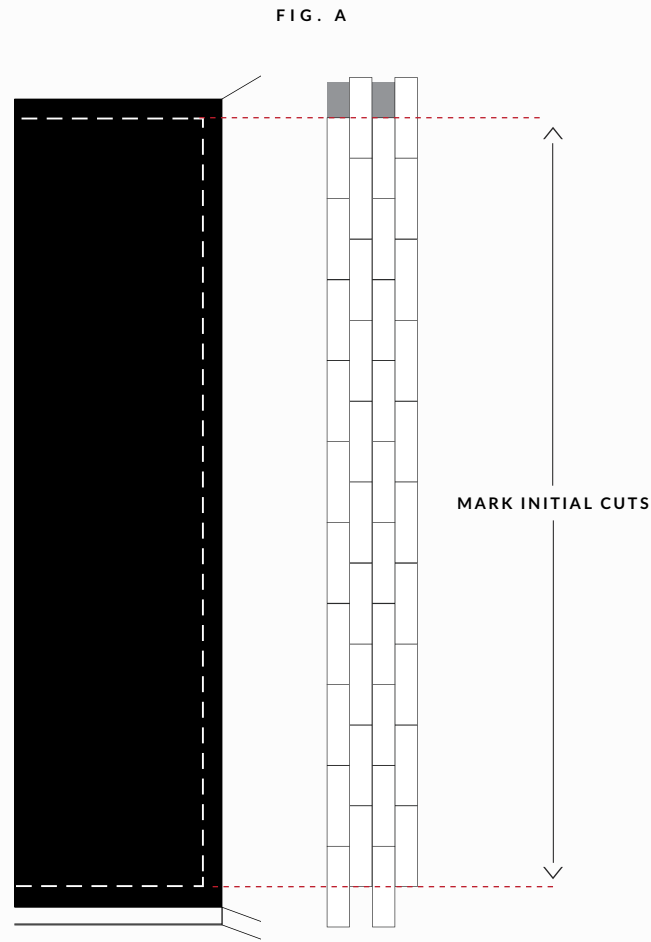

PREPARATION

STEP 5

Measure and mark your horizontal and vertical guidelines using a laser level and chalk line in accordance with the tile dimensions.

TOOLS: LASER LEVEL
CHALK LINE

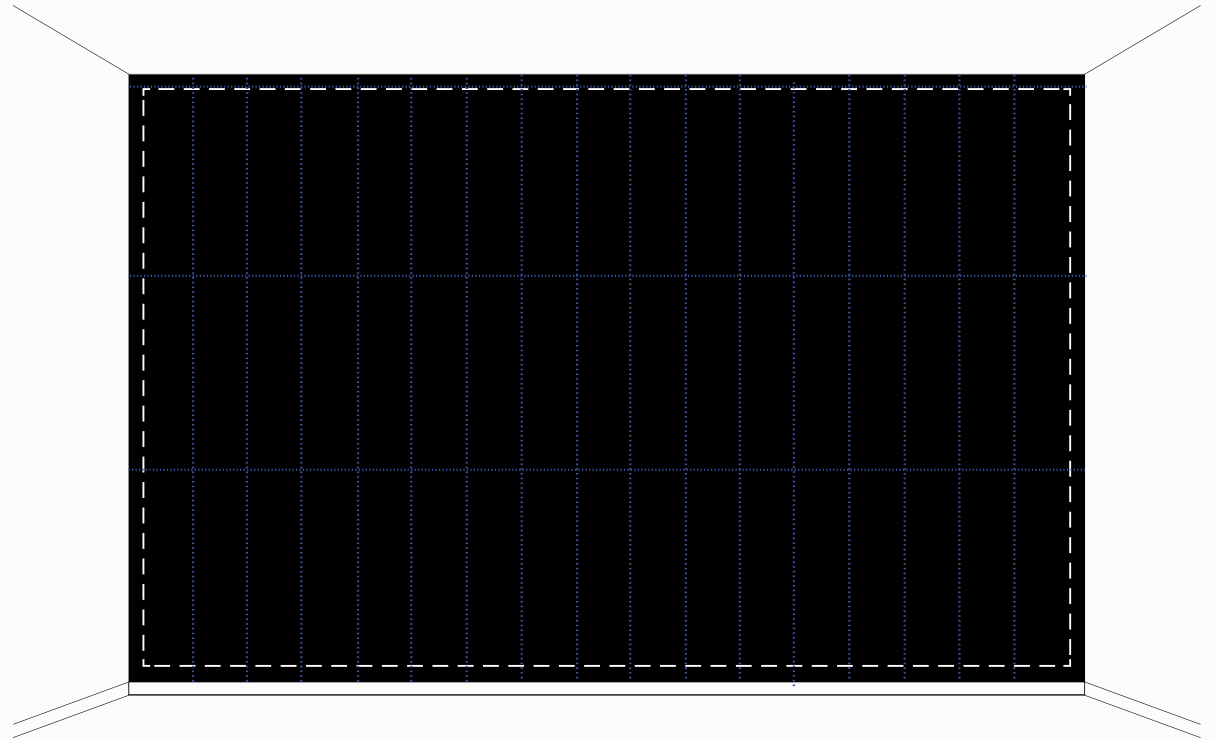

PREPARATION

STEP 6

In prep for outlets, light switches, etc., arrange any other rows of tiles on the floor that will require additional cuts, taking care to mark any outlets and define initial cuts once level; please see special instructions for installing mouldings.

Anticipate final row might need to be trimmed to fit as well.

RULER
TOOLS: JIGSAW AND DRILL
MITER SAW OR TABLE SAW

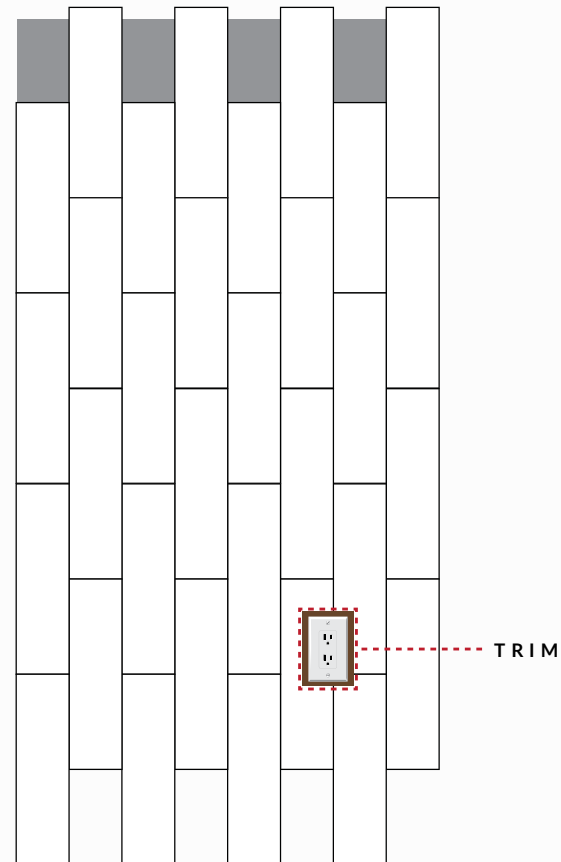

FASTENING

STEP 7

To install VERTICALLY, begin in any corner as long as the hardboard back panel is facing the direction of the install. Define and mark initial cuts.

FIG A. Starting from the Top, place the visible hardboard back panel to the Bottom.

FIG B. Starting from the Bottom, the visible hardboard back panel should be on the Top.

(NOTE: Initial cuts will vary depending on your desired installation area.)

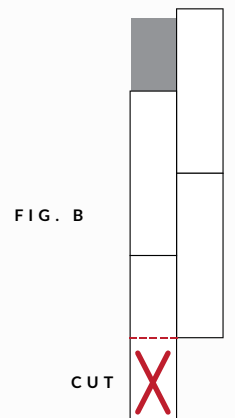
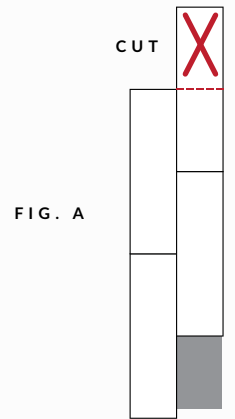
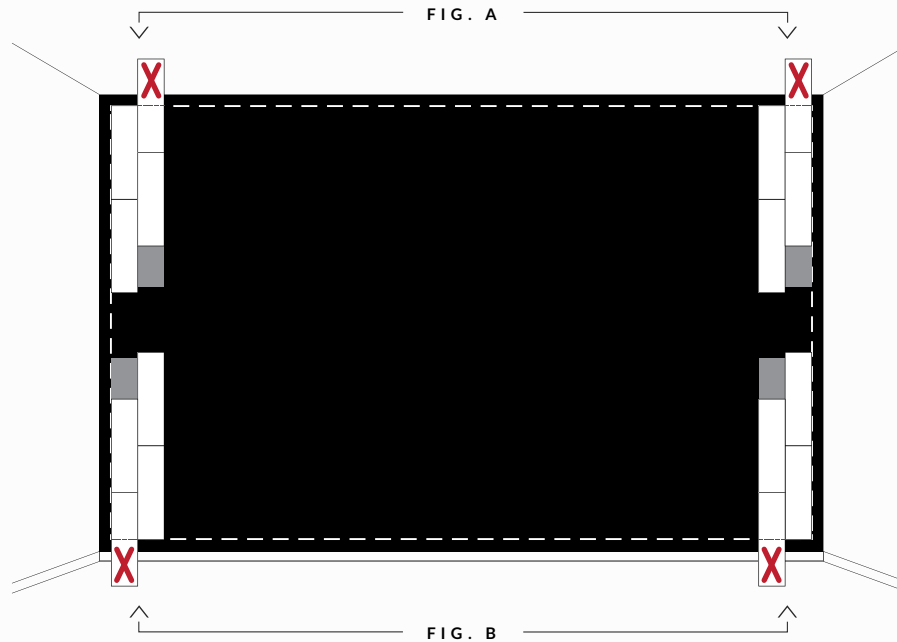

FASTENING

STEP 8

Cut any excess tab off the wall tile in order to be flush with the edge of the wall and ensure proper coverage.

Please note that when cutting any pattern, pieces may fall off due to the vibration of the saw. Simply, glue back on and nail from back to secure it firmly.

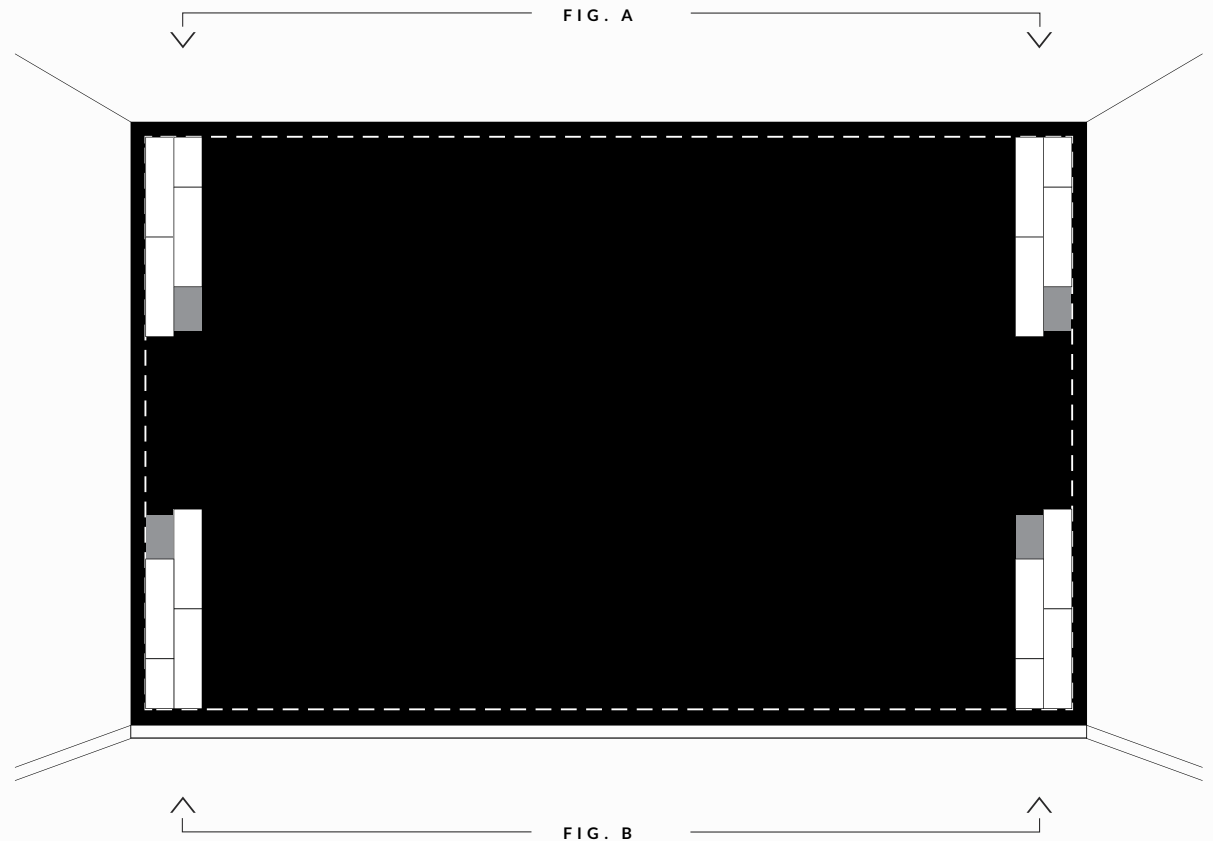

FASTENING

STEP 9

Add adhesive on the back panel, and place the initial tile at the starting point of the installation.

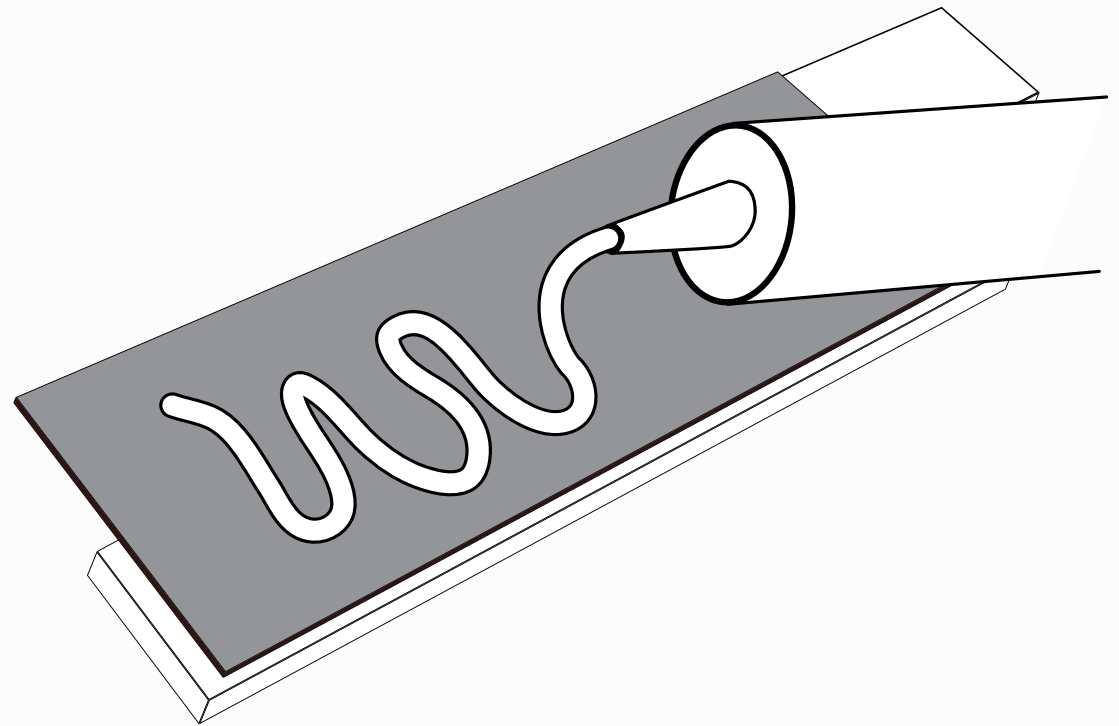

TOOLS: CONSTRUCTION ADHESIVE
APPLICATOR

FASTENING

STEP 10

Once level and aligned, fasten the exposed back panel with at least 4 #18 Gauge Nails.

(OPTIONAL: If using flathead screws, be sure to use a Counter Sink bit first to drill screws below the surface.)

TOOLS: 18 GAUGE NAIL GUN WITH NAILS

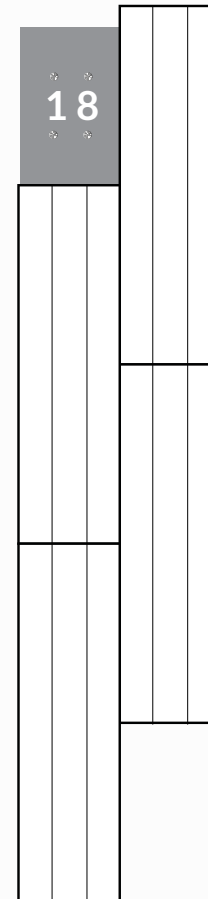

FASTENING

STEP 11

Apply pressure on the individual piece when nailing.

Using #23 Gauge Nails, nail in between individual wood pieces, taking care to hide the nails within the 3D volume of each design.

When possible, do not nail on the face of each insert to maintain the finished aesthetic of the wall covering.

TOOLS: 23 GAUGE NAIL GUN WITH NAILS

FIG. A
ABOVE EYE LEVEL, USE #23 GAUGE NAILS AT A DOWNWARD ANGLE.

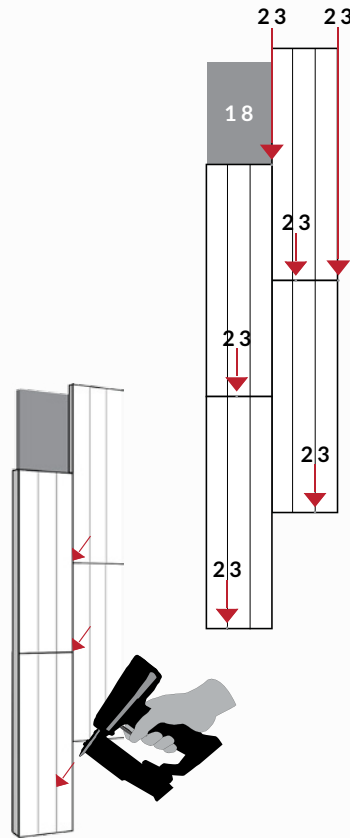

FIG. B
AT EYE LEVEL, USE #23 GAUGE NAILS, NAILING INTO THE EDGES OF EACH PANEL.

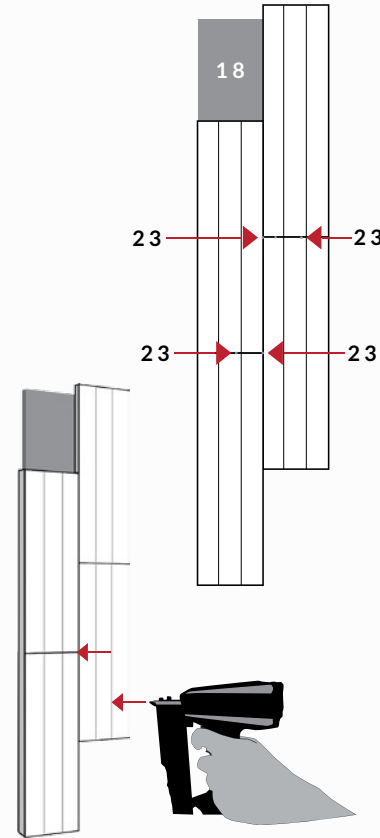
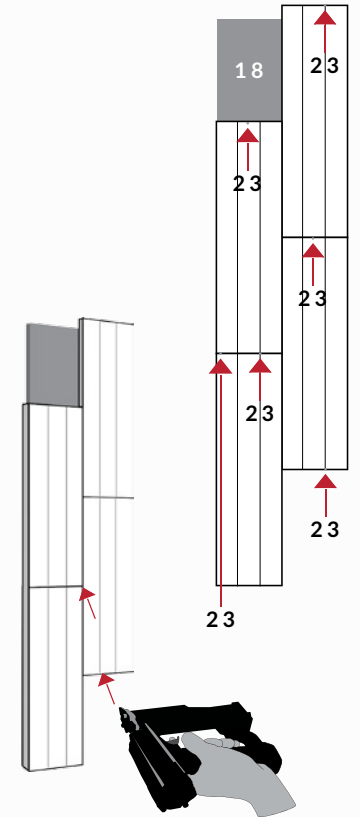

FIG. C
BELOW EYE LEVEL, USE #23 GAUGE NAILS, NAILING AT AN UPWARD ANGLE TO AVOID VISIBLE NAILS.



FASTENING

STEP 12

Now, apply a very small amount of adhesive on the exposed hardwood panel in preparation for the next tile.

TOOLS: CONSTRUCTION ADHESIVE
APPLICATOR

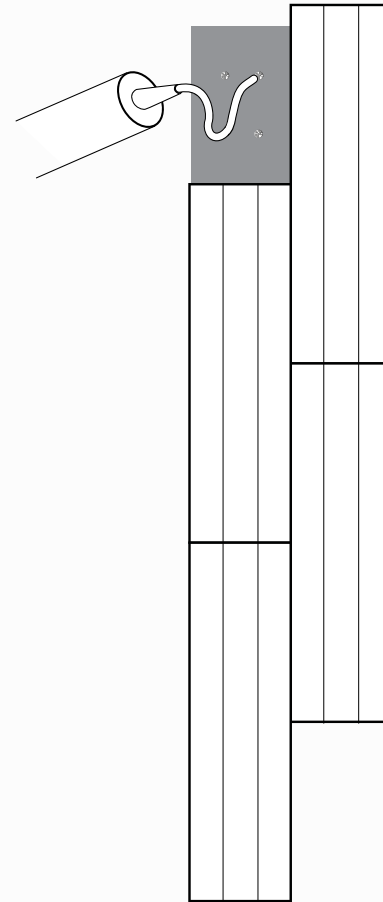

FASTENING

STEP 13

Tightly fit the next adjacent tile; if necessary, use a rubber mallet and a scrap piece of wood to assist.

Remember, a 1/16" separation is normal, as each handmade piece must be allowed to expand and contract.

TOOLS: RUBBER MALLET

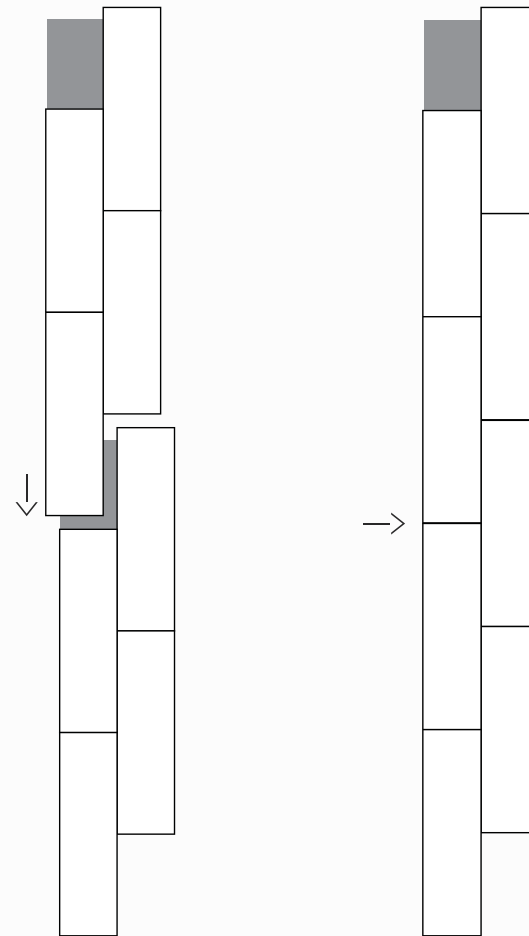

FASTENING

STEP 14

Make sure each tile and row is level.

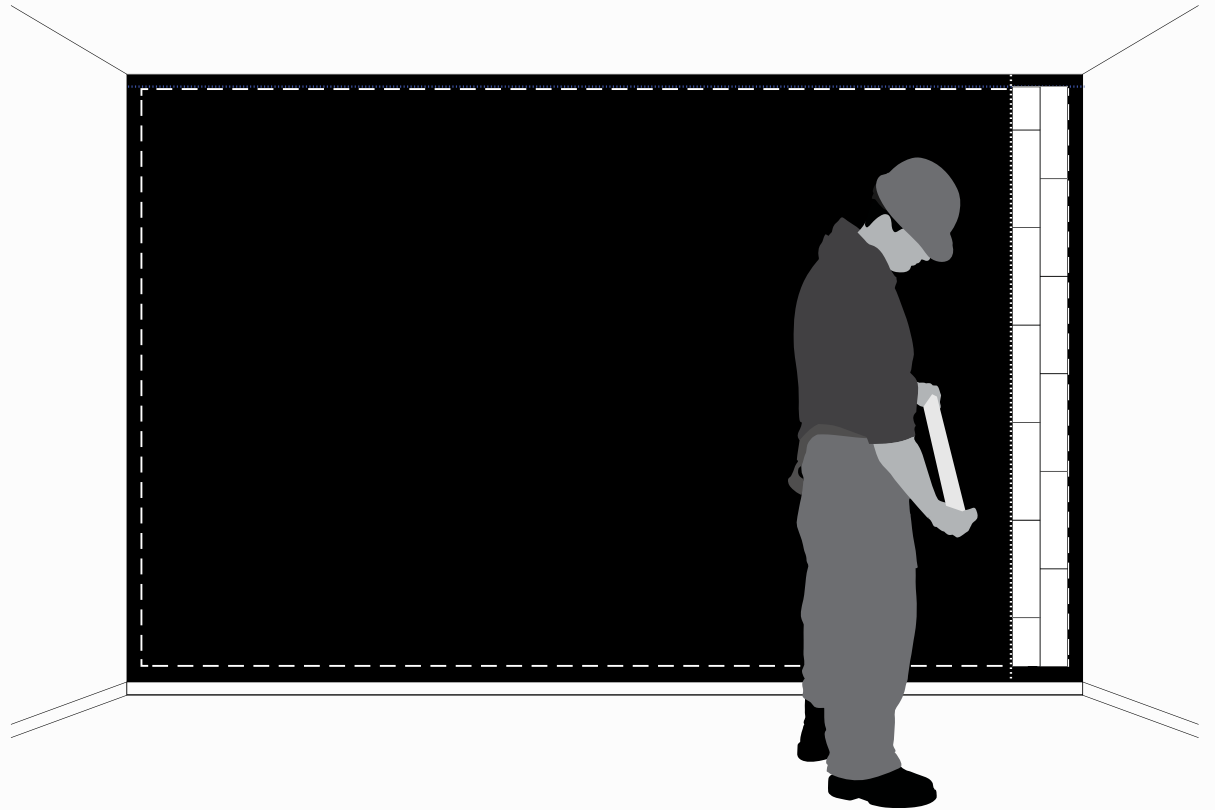

TOOLS: LASER LEVEL OR LEVEL

FASTENING

STEP 15

Repeat this fastening process across the wall, making sure to cut any tiles to fit as you approach the end of the wall.

REMEMBER: THE PANELS MUST BE GLUED AND NAILED FOR THE WARRANTY TO APPLY;
THIS METHOD WILL ALSO PREVENT THE PANELS FROM WARPING IN THE FUTURE.

SPECIAL APPLICATIONS

FOR OUTLETS, LIGHT SWITCHES, BUTTONS, ETC...

STEP 1

Mark your outlet distance and elevation on your test pattern and on the wall.

STEP 2

Mark your tile and drill 4 holes for each corner of the outlet.

STEP 3

Using a Jigsaw to cut a line from corner to corner.

STEP 4

Turn the piece around, trim and detail.

STEP 5

Test on wall before applying glue/nails.

FIREPLACES & HEATERS

We do not recommend the use of DuChâteau Wall Coverings around a fireplace or a heater. Being made from wood, DuChâteau Wall Coverings are inherently flammable. Check your local codes.

In most areas, this is prohibited by code. Optional “A” Rating fire retardant is available for an additional fee.

BATHROOMS

DuChâteau Wall Coverings may be used in bathrooms as long as they are NOT installed at or near splash areas.

CEILING APPLICATIONS

In general, we do not recommend using these products for ceiling applications; this specifically includes Arc Chevron, Crest, Curva Chevron, Curva, Krescent, Kuadra, Metamorphosis, Parallels, Scale Reckt, Tresses, Vertex, and Wave styles.

However, if Edge, Infuse and Kubik styles are used in a ceiling application, use three #18 Gauge Nails over each solid part of the tile as an extra precaution and must be installed by a Licensed Flooring Contractor or Licensed Finish Carpenter with ceiling installation experience. Special glues and nail size must be specified by the Project Engineer and/or signing Architect for the project and also combined with the use of #18 Gauge Nails along the edges of each tile.

CONCRETE WALLS

For installation over concrete walls, wood separators and OSB boards are recommended. Direct installation over concrete is NOT covered by the warranty.

MOULDINGS

For a truly finished look, DuChâteau recommends its exclusive mouldings for all our wall coverings. Please note DuChâteau Wall Covering tiles can be mitered on corners to accommodate mouldings. Be sure to cut the mouldings at the same length on each side to ensure the 3-D heights match. Visit website (www.duchateau.com) for more information.

CUSTOM MOULDINGS

DUCHÂTEAU CAN MANUFACTURE ANY CUSTOM TRIM YOU MAY NEED WITH THE SAME WOOD SPECIES AND FINISHES OF DUCHÂTEAU WALL COVERING TILES (OUTLET TRIM, WINDOW TRIM, CASING, BASEBOARD, CROWN, ETC.). PLEASE CONTACT US FOR A QUOTE AT 1.888.DUCHATEAU OR SALES@DUCHATEAU.COM.